

- o Flat Cable Connectors SEK
- o *har-mik®*
- o D-Sub
- o InduCom

Applications



Product details

09 18 116 9621
Pcb transition connector, 2 rows

Rows	2 rows
Connector size	16 contacts
Termination	PCB transition for flat cable
Profile	Standard version
Termination	solder pins
Height	7.45 mm
RoHS compliant	Yes

Available Downloads

Title	Format	
Data sheet	PDF	download
CAD data 2D	DXF	download

Further links

- 3D-Library
-

Inquiry

Printed board layout, component side

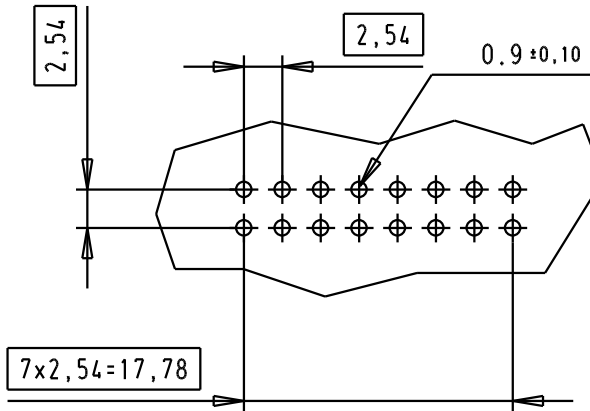
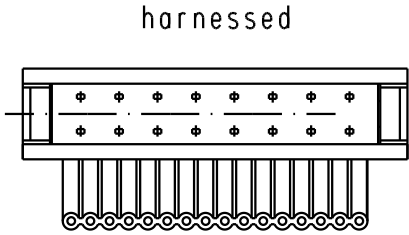

pre assembled

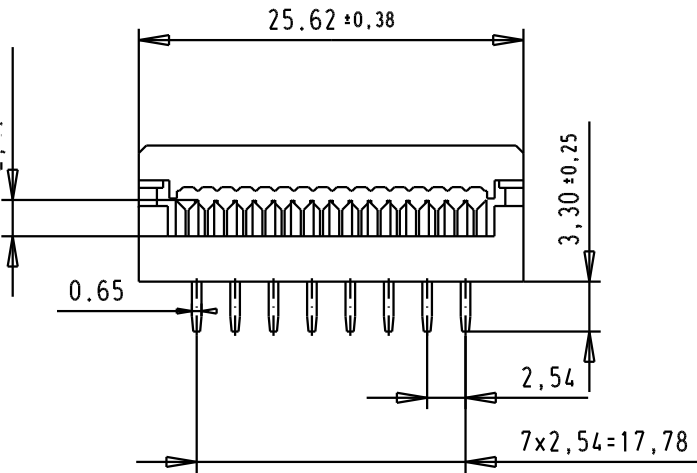

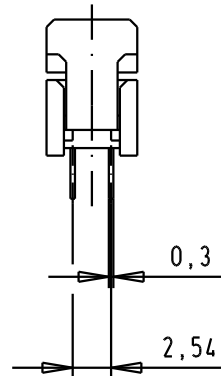

pre assembled

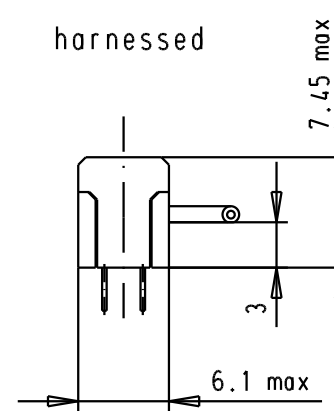

harnessed

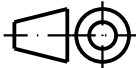

				Dat.	Name	 All Dim. in mm Orig. Size DIN A 4	SEK 18, P.C.B Transition 16 poles connector 2 rows	Maßstab/ Scale
			Detail.	3.2.92	BP			2:1
			Insp.					
			Stand.					
32151	01/09/04	TR	HARTING EURL F-95972 Paris				TB 09181169621	Blatt/ Page
31575	26-NOV-03	SH			1			
26573	10.02.00	PP			1			
	Mod.	Dat.	Name			Sub.		

1.200	NON-ASSEMBLED
0621	PRE-ASSEMBLED
er	Cover